

Data Sheet



Article number: 03706020

Description: Fluro rod end BRF 20
with ball bearing

Measures

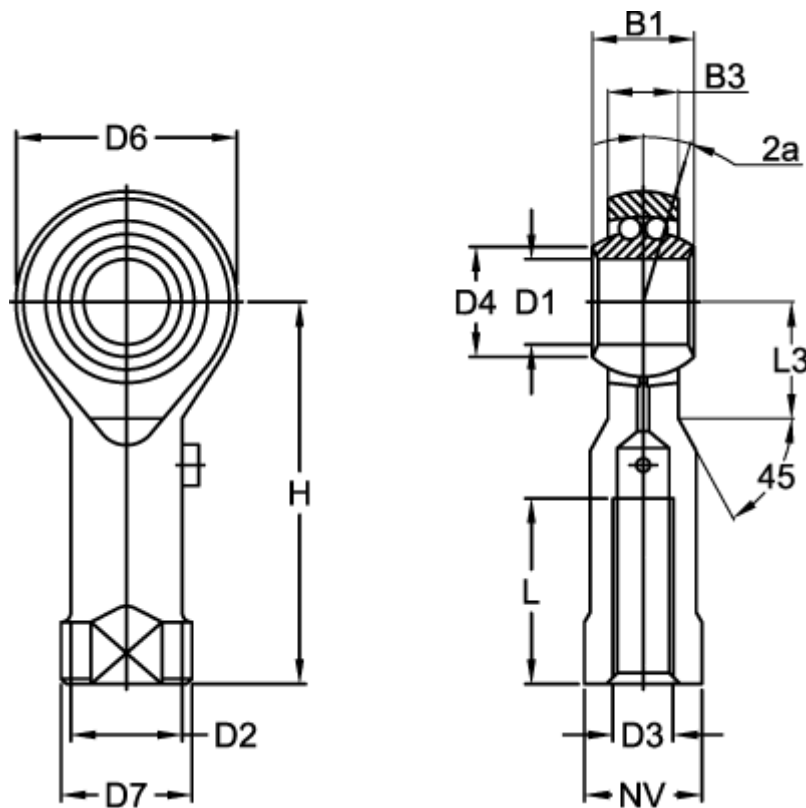

Angel 2a = 7.0	D7 = 34
B1 = 25	Dynamic load C (N) = 7900
B3 = 18.00	H = 77
D1 = 20	L = 33
D2 = 27.5	L3 = 26
D3 = M20x1,5	Max rpm = 825
D4 = 24.5	NV = 30
D6 = 50	Static load (N) = 3450

Weight (kg) = 0.367